

CMOS 8-STAGE STATIC SHIFT REGISTER

Check for Samples: [CD4021B-Q1](#)

FEATURES

- Qualified for Automotive Applications
- Medium-Speed Operation: 12-MHz (Typ) Clock Rate at $V_{DD} - V_{SS} = 10\text{ V}$
- Fully Static Operation
- Eight Master-Slave Flip-Flops Plus Output Buffering and Control Gating
- 100% Tested for Quiescent Current at 20 V
- Maximum Input Current of 1 μA at 18 V Over Full Package-Temperature Range: 100 nA at 18 V and 25°C
- Noise Margin (Full Package-Temperature Range):
 - 1 V at $V_{DD} = 5\text{ V}$
 - 2 V at $V_{DD} = 10\text{ V}$
 - 2.5 V at $V_{DD} = 15\text{ V}$
- Standardized Symmetrical Output Characteristics
- 5-V, 10-V, and 15-V Parametric Ratings

- Meets All Requirements of JEDEC Tentative Standard No. 13B, "Standard Specifications for Description of 'B' Series CMOS Devices"
- Latch-Up Performance Meets 50 mA per JESD 78, Class I

APPLICATIONS

- Parallel Input/Serial Output Data Queuing
- Parallel-to-Serial Data Conversion
- General-Purpose Register

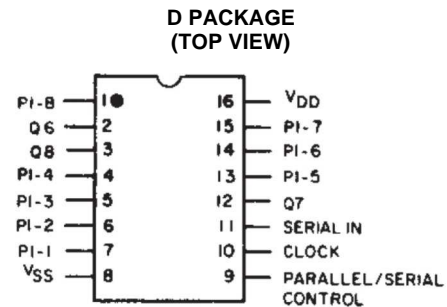

DESCRIPTION

CD4021B series types are 8-stage parallel- or serial-input/serial output registers having common CLOCK and PARALLEL/SERIAL CONTROL inputs, a single SERIAL data input, and individual parallel "JAM" inputs to each register stage. Each register stage is a D-type, master-slave flip-flop. In addition to an output from stage 8, "Q" outputs are also available from stages 6 and 7. Parallel as well as serial entry is made into the register synchronously with the positive clock line transition in the CD4014B. In the CD4021B serial entry is synchronous with the clock but parallel entry is asynchronous. In both types, entry is controlled by the PARALLEL/SERIAL CONTROL input. When the PARALLEL/SERIAL CONTROL input is low, data is serially shifted into the 8-stage register synchronously with the positive transition of the clock line. When the PARALLEL/SERIAL CONTROL input is high, data is jammed into the 8-stage register via the parallel input lines and synchronous with the positive transition of the clock line. In the CD4021B, the CLOCK input of the internal stage is "forced" when asynchronous parallel entry is made. Register expansion using multiple packages is permitted.

The CD4021B series types are supplied in 16-lead hermetic dual-in-line ceramic packages (D and F suffixes), 16-lead dual-in-line plastic packages (E suffix), and in chip form (H suffix).

ORDERING INFORMATION⁽¹⁾

T_A	PACKAGE ⁽²⁾		ORDERABLE PART NUMBER	TOP-SIDE MARKING
–40°C to 125°C	SOIC – D	Reel of 2500	CD4010BQDRQ1	CD4021BQ

(1) For the most current package and ordering information, see the Package Option Addendum at the end of this document, or see the TI web site at www.ti.com.

(2) Package drawings, thermal data, and symbolization are available at www.ti.com/packaging.



Please be aware that an important notice concerning availability, standard warranty, and use in critical applications of Texas Instruments semiconductor products and disclaimers thereto appears at the end of this data sheet.



This integrated circuit can be damaged by ESD. Texas Instruments recommends that all integrated circuits be handled with appropriate precautions. Failure to observe proper handling and installation procedures can cause damage.

ESD damage can range from subtle performance degradation to complete device failure. Precision integrated circuits may be more susceptible to damage because very small parametric changes could cause the device not to meet its published specifications.

Functional Diagram

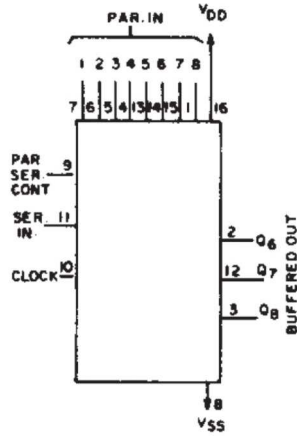

Logic Diagram

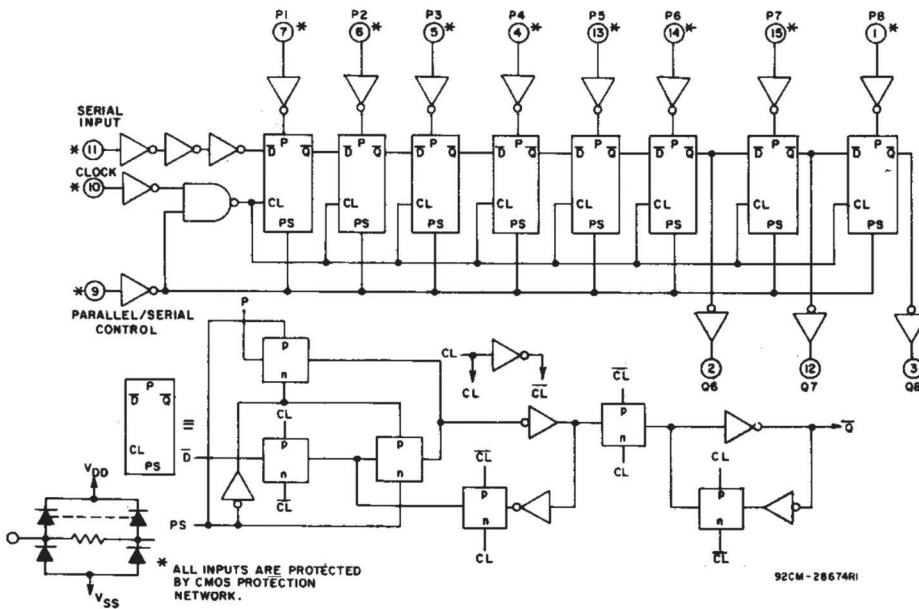

TRUTH TABLE – CD4021B

CL	Serial Input	Parallel/Serial Control	PI-1	PI-n	Q1 (Internal)	Qn
X	X	1	0	0	0	0
X	X	1	0	1	0	1
X	X	1	1	0	1	0
X	X	1	1	1	1	1
	0	0	X	X	0	Q _{n-1}
	1	0	X	X	1	Q _{n-1}
	X	0	X	X	Q ₁	Q _n NC

X = DON'T CARE CASE

ABSOLUTE MAXIMUM RATINGS⁽¹⁾

over operating free-air temperature range (unless otherwise noted)

		VALUE	UNIT
V _{DD}	DC supply voltage range (voltage referenced to V _{SS} terminal)	–0.5 to +20	V
	Input voltage range, all inputs	–0.5 to V _{DD} +0.5	V
	DC input current, any one input	±10	mA
P _D	Power dissipation per package	T _A = –40°C to +100°C	500
		T _A = +100°C to +125°C	Derate Linearity at 12mW/°C to 20 mW
P _D	Device dissipation per output transistor	100	mW
T _A	Operating temperature range	–40 to +125	°C
T _{stg}	Storage temperature range	–65 to +150	°C
ESD	Electrostatic discharge rating ⁽²⁾	Human-body model (HBM)	2000
		Machine model (MM)	200
		Charged-Device Model (CDM)	1000
Latch-up performance per JESD 78, Class I		50	mA

- (1) Stresses beyond those listed under *absolute maximum ratings* may cause permanent damage to the device. These are stress ratings only, and functional operation of the device at these or any other conditions beyond those indicated under *recommended operating conditions* is not implied. Exposure to absolute-maximum-rated conditions for extended periods may affect device reliability.
- (2) Tested in accordance with AEC-Q100.

RECOMMENDED OPERATING CONDITIONS

At $T_A = 25^\circ\text{C}$, unless otherwise specified. For maximum reliability, nominal operating conditions should be selected so that operation is always within the following ranges.

		V_{DD}	MIN	MAX	UNIT
	Supply voltage range ($T_A =$ full package-temperature range)		3	18	V
t_W	Clock pulse width	5	180		ns
		10	80		
		15	50		
f_{CL}	Clock frequency	5		3	MHz
		10		6	
		15		8.5	
t_{rCL} , t_{fCL}	Clock rise and fall time	5		15	μs
		10		15	
		15		15	
t_s	Serial input (referred to CL)	5	120		ns
		10	80		
		15	60		
	Parallel inputs CD4014B (referred to CL)	5	80		ns
		10	50		
		15	40		
	Parallel inputs CD4021B (referred to P/S)	5	50		ns
		10	30		
		15	20		
	Parallel/Serial Control CD4014B (referred to CL)	5	180		ns
		10	80		
		15	60		
t_W	Parallel/serial pulse width	5	160		ns
		10	80		
		15	50		
t_{REM}	Parallel/serial removal time	5	280		ns
		10	140		
		15	100		

STATIC ELECTRICAL CHARACTERISTICS

PARAMETER	TEST CONDITIONS			LIMITS AT INDICATED TEMPERATURES (°C)						UNIT
	V _D (V)	V _{IN} (V)	V _{DD} (V)	-40	+85	+125	+25			
							5	150	150	
I _{DD} Max Quiescent device current		0.5	5	10	300	300	0.04 5			
		0.10	10	20	600	600	0.04 10			
		0.15	15	100	3000	3000	0.04 20			
		0.20	20	0.61	0.42	0.36	0.08 100			
I _{OL} Min Output low (sink) current	0.4	0.5	5	1.5	1.1	0.9	0.51	1		
	0.5	0.10	10	4	2.8	2.4	1.3	2.6		
	1.5	0.15	15	-0.61	-0.42	-0.36	3.4	6.8		
I _{OH} Min Output high (source) current	4.6	0.5	5	-1.8	-1.3	-1.15	-0.51	-1		
	2.5	0.5	5	-1.5	-1.1	-0.9	-1.6	-3.2		
	9.5	0.10	10	-4	-2.8	-2.4	-1.3	-2.6		
	13.5	0.15	15	-4.2			-3.4	-6.8		
V _{OL} Max Output voltage: low level		0.5	5	0.05			0 0.05			
		0.10	10	0.05			0 0.05			
		0.15	15	0.05			0 0.05			
V _{OH} Min Output voltage: high level		0.5	5	4.95			4.95	5		
		0.10	10	9.95			9.95	10		
		0.15	15	14.95			14.95	15		
V _{IL} Max Input low voltage	0.5, 4.5		5	1.5			1.5			
	1, 9		10	3			3			
	1.5, 13.5		15	4			4			
V _{IH} Min Input high voltage	0.5, 4.5		5	3.5			3.5			
	1, 9		10	7			7			
	1.5, 13.5		15	11			11			
I _{IN} Max Input current		0, 18	18	±0.1	±1	±1	±10 ⁻⁵ ±0.1			

DYNAMIC ELECTRICAL CHARACTERISTICS
 $T_A = 25^\circ\text{C}$, Input $t_r/t_f = 20\text{ ns}$, $C_L = 50\text{ pF}$, $R_L = 200\text{ k}\Omega$

PARAMETER		TEST CONDITIONS	V_{DD}	MIN	TYP	MAX	UNIT
t_{PLH} , t_{PHL}	Propagation delay time		5		160	320	ns
			10		80	160	
			15		30	120	
t_{THL} , t_{TLH}	Transition time		5		100	200	ns
			10		50	100	
			15		40	80	
f_{CL}	Maximum clock input ⁽¹⁾		5	3	6		MHz
			10	6	12		
			15	8.5	17		
t_W	Minimum clock pulse width ⁽¹⁾		5		90	180	ns
			10		40	80	
			15		25	50	
t_{rCL} , t_{fCL}	Clock rise and fall time ⁽²⁾⁽¹⁾		5			15	μs
			10			15	
			15			15	
t_s	Minimum setup time ⁽¹⁾	Serial input (referred to CL)	5		60	120	ns
			10		40	80	
			15		30	60	
		Parallel inputs (referred to CL)	5		40	80	
			10		25	50	
			15		20	40	
		Parallel inputs (referred to P/S)	5		25	50	
			10		15	30	
			15		10	20	
		Serial in, Parallel in, Parallel/Serial Control	5		90	180	
			10		40	80	
			15		30	60	
t_H	Minimum hold time ⁽¹⁾		5			0	ns
			10			0	
			15			0	
t_{WH}	Minimum P/S pulse width ⁽¹⁾		5		80	160	ns
			10		40	80	
			15		25	50	
t_{REM}	Minimum P/S removal time ⁽¹⁾		5		140	280	ns
			10		70	140	
			15		50	100	
C_I	Average input capacitance ⁽¹⁾			5	7.5	pF	

(1) Not production tested

(2) If more than one unit is cascaded, t_{rCL} should be made less than or equal to the sum of the transition time and the fixed propagation delay of the output of the driving stage for the estimated capacitive load.

Typical Characteristics

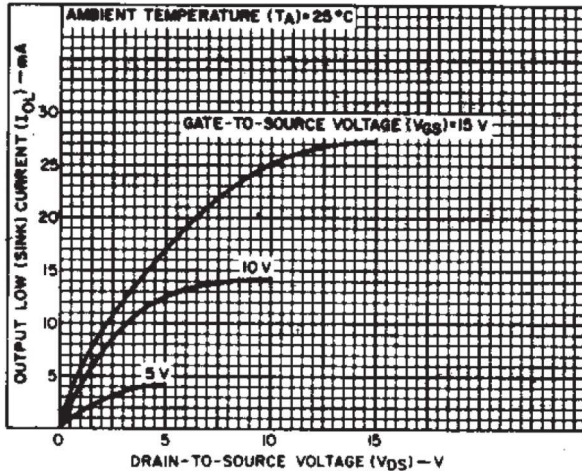

Figure 1. Typical Output Low (Sink) Current Characteristics

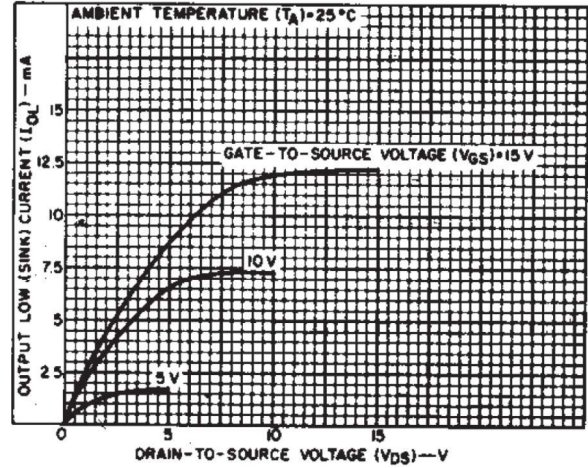

Figure 2. Minimum Output Low (Sink) Current Characteristics

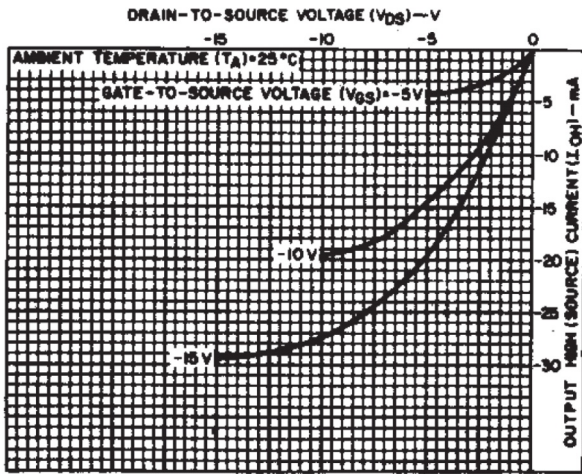

Figure 3. Typical Output High (Source) Current Characteristics

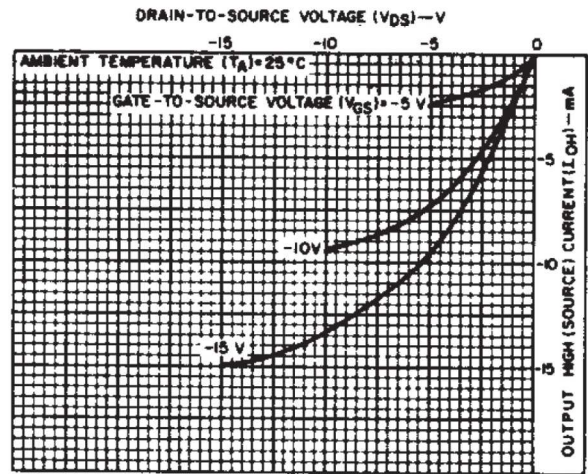

Figure 4. Minimum Output High (Source) Current Characteristics

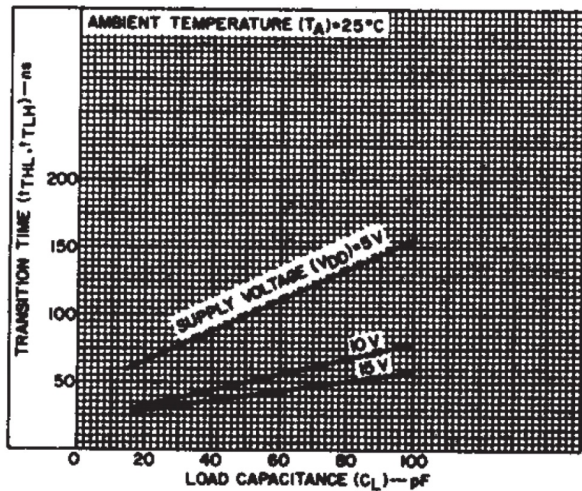

Figure 5. Typical Transition Time as a Function of Load Capacitance

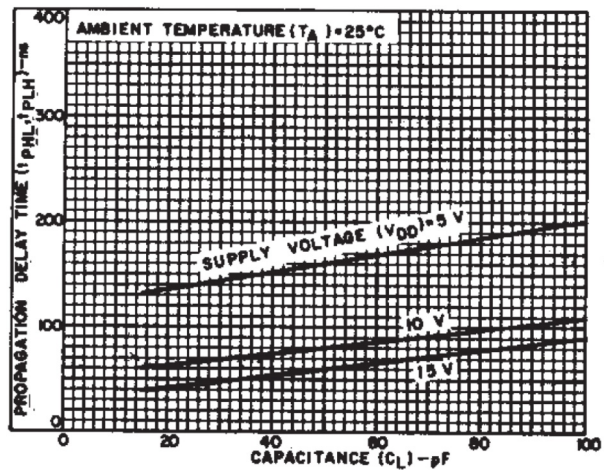

Figure 6. Typical Propagation Delay Times as a Function of Load Capacitance

Typical Characteristics (continued)

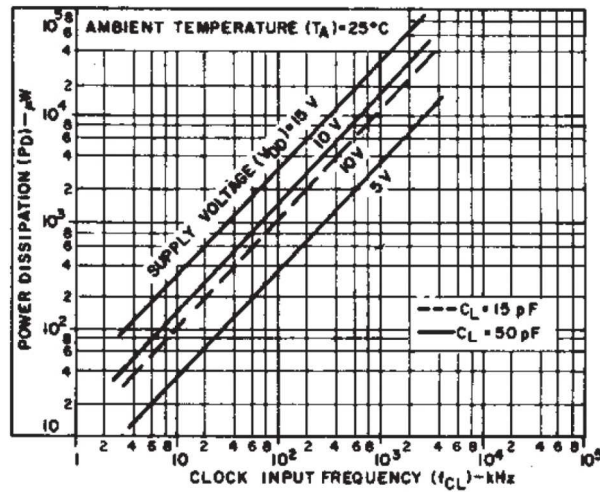

Figure 7. Typical Dynamic Power Dissipation as a Function of Clock Input Frequency

PARAMETER MEASUREMENT INFORMATION

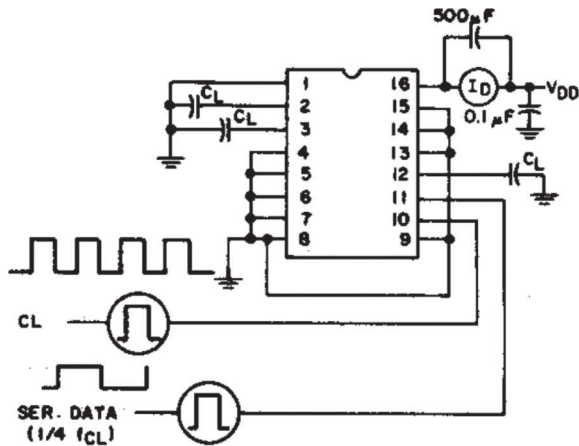

Figure 8. Dynamic Power Dissipation Test Circuit

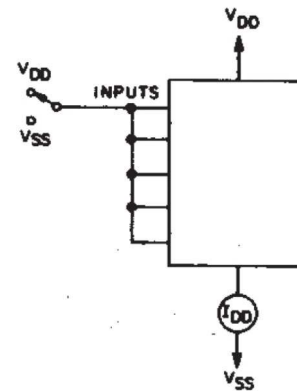

Figure 9. Quiescent Device Current Test Circuit

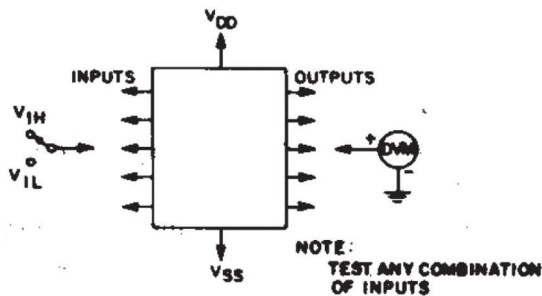

Figure 10. Input Voltage Test Circuit

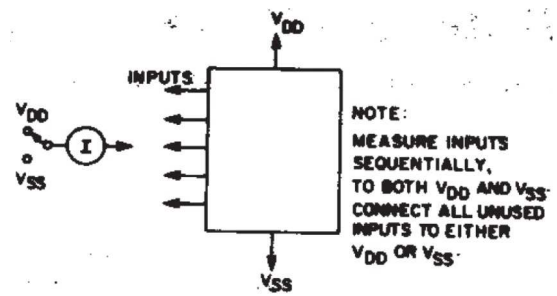
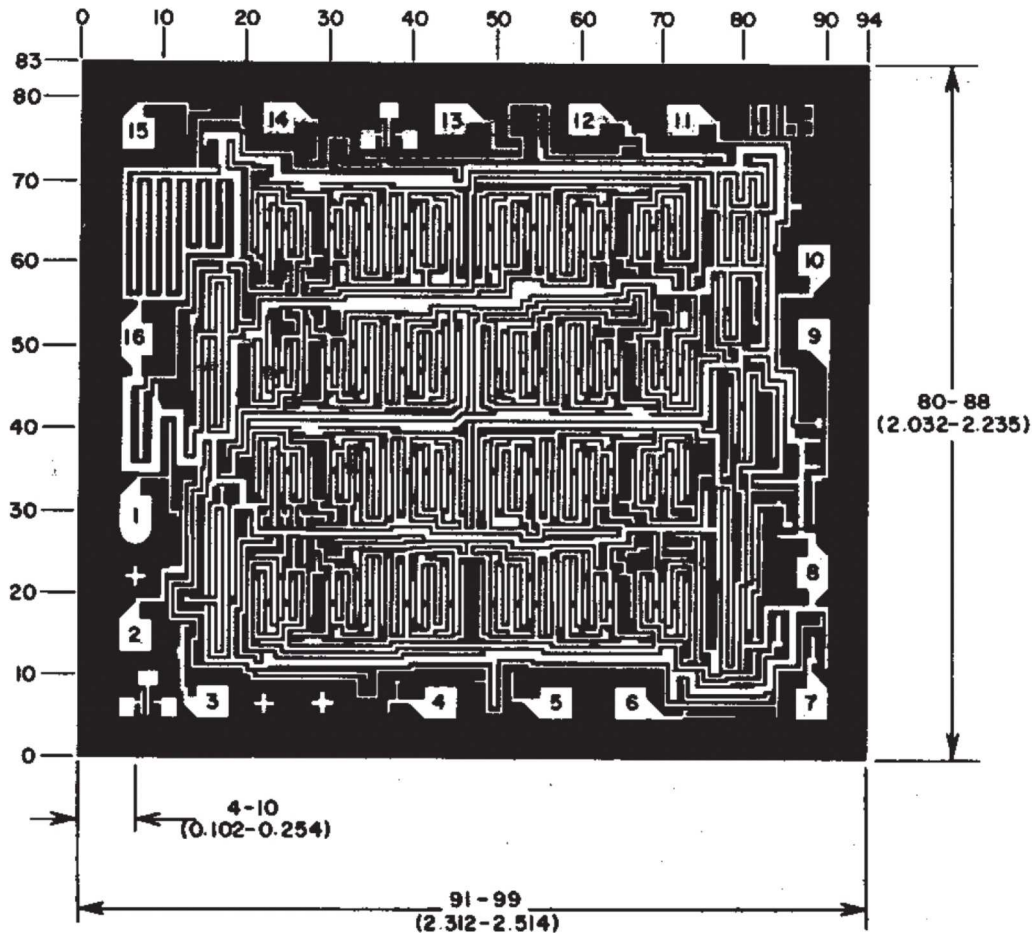

Figure 11. Input Current Test Circuit



Note: Dimensions in parentheses are in millimeters and are derived from the basic inch dimensions as indicated. Grid graduation are in mils (10^{-3} inch).

Figure 12. Dimensions and Pad Layout

PACKAGING INFORMATION

Orderable Device	Status (1)	Package Type	Package Drawing	Pins	Package Qty	Eco Plan (2)	Lead/Ball Finish	MSL Peak Temp (3)	Op Temp (°C)	Top-Side Markings (4)	Samples
CD4021BQDRQ1	ACTIVE	SOIC	D	16	2500	Green (RoHS & no Sb/Br)	CU NIPDAU	Level-1-260C-UNLIM	-40 to 125	CD4021BQ	Samples

(1) The marketing status values are defined as follows:

ACTIVE: Product device recommended for new designs.

LIFEBUY: TI has announced that the device will be discontinued, and a lifetime-buy period is in effect.

NRND: Not recommended for new designs. Device is in production to support existing customers, but TI does not recommend using this part in a new design.

PREVIEW: Device has been announced but is not in production. Samples may or may not be available.

OBSOLETE: TI has discontinued the production of the device.

(2) Eco Plan - The planned eco-friendly classification: Pb-Free (RoHS), Pb-Free (RoHS Exempt), or Green (RoHS & no Sb/Br) - please check <http://www.ti.com/productcontent> for the latest availability information and additional product content details.

TBD: The Pb-Free/Green conversion plan has not been defined.

Pb-Free (RoHS): TI's terms "Lead-Free" or "Pb-Free" mean semiconductor products that are compatible with the current RoHS requirements for all 6 substances, including the requirement that lead not exceed 0.1% by weight in homogeneous materials. Where designed to be soldered at high temperatures, TI Pb-Free products are suitable for use in specified lead-free processes.

Pb-Free (RoHS Exempt): This component has a RoHS exemption for either 1) lead-based flip-chip solder bumps used between the die and package, or 2) lead-based die adhesive used between the die and leadframe. The component is otherwise considered Pb-Free (RoHS compatible) as defined above.

Green (RoHS & no Sb/Br): TI defines "Green" to mean Pb-Free (RoHS compatible), and free of Bromine (Br) and Antimony (Sb) based flame retardants (Br or Sb do not exceed 0.1% by weight in homogeneous material)

(3) MSL, Peak Temp. -- The Moisture Sensitivity Level rating according to the JEDEC industry standard classifications, and peak solder temperature.

(4) Multiple Top-Side Markings will be inside parentheses. Only one Top-Side Marking contained in parentheses and separated by a "~" will appear on a device. If a line is indented then it is a continuation of the previous line and the two combined represent the entire Top-Side Marking for that device.

Important Information and Disclaimer: The information provided on this page represents TI's knowledge and belief as of the date that it is provided. TI bases its knowledge and belief on information provided by third parties, and makes no representation or warranty as to the accuracy of such information. Efforts are underway to better integrate information from third parties. TI has taken and continues to take reasonable steps to provide representative and accurate information but may not have conducted destructive testing or chemical analysis on incoming materials and chemicals. TI and TI suppliers consider certain information to be proprietary, and thus CAS numbers and other limited information may not be available for release.

In no event shall TI's liability arising out of such information exceed the total purchase price of the TI part(s) at issue in this document sold by TI to Customer on an annual basis.

OTHER QUALIFIED VERSIONS OF CD4021B-Q1 :

- Catalog: [CD4021B](#)

- Military: [CD4021B-MIL](#)

NOTE: Qualified Version Definitions:

- Catalog - TI's standard catalog product
- Military - QML certified for Military and Defense Applications

D (R-PDSO-G16)

PLASTIC SMALL OUTLINE



- NOTES:
- A. All linear dimensions are in inches (millimeters).
 - B. This drawing is subject to change without notice.
 - C. Body length does not include mold flash, protrusions, or gate burrs. Mold flash, protrusions, or gate burrs shall not exceed 0.006 (0,15) each side.
 - D. Body width does not include interlead flash. Interlead flash shall not exceed 0.017 (0,43) each side.
 - E. Reference JEDEC MS-012 variation AC.

D (R-PDSO-G16)

PLASTIC SMALL OUTLINE



4211283-4/E 08/12

- NOTES:
- All linear dimensions are in millimeters.
 - This drawing is subject to change without notice.
 - Publication IPC-7351 is recommended for alternate designs.
 - Laser cutting apertures with trapezoidal walls and also rounding corners will offer better paste release. Customers should contact their board assembly site for stencil design recommendations. Refer to IPC-7525 for other stencil recommendations.
 - Customers should contact their board fabrication site for solder mask tolerances between and around signal pads.

IMPORTANT NOTICE

Texas Instruments Incorporated and its subsidiaries (TI) reserve the right to make corrections, enhancements, improvements and other changes to its semiconductor products and services per JESD46, latest issue, and to discontinue any product or service per JESD48, latest issue. Buyers should obtain the latest relevant information before placing orders and should verify that such information is current and complete. All semiconductor products (also referred to herein as "components") are sold subject to TI's terms and conditions of sale supplied at the time of order acknowledgment.

TI warrants performance of its components to the specifications applicable at the time of sale, in accordance with the warranty in TI's terms and conditions of sale of semiconductor products. Testing and other quality control techniques are used to the extent TI deems necessary to support this warranty. Except where mandated by applicable law, testing of all parameters of each component is not necessarily performed.

TI assumes no liability for applications assistance or the design of Buyers' products. Buyers are responsible for their products and applications using TI components. To minimize the risks associated with Buyers' products and applications, Buyers should provide adequate design and operating safeguards.

TI does not warrant or represent that any license, either express or implied, is granted under any patent right, copyright, mask work right, or other intellectual property right relating to any combination, machine, or process in which TI components or services are used. Information published by TI regarding third-party products or services does not constitute a license to use such products or services or a warranty or endorsement thereof. Use of such information may require a license from a third party under the patents or other intellectual property of the third party, or a license from TI under the patents or other intellectual property of TI.

Reproduction of significant portions of TI information in TI data books or data sheets is permissible only if reproduction is without alteration and is accompanied by all associated warranties, conditions, limitations, and notices. TI is not responsible or liable for such altered documentation. Information of third parties may be subject to additional restrictions.

Resale of TI components or services with statements different from or beyond the parameters stated by TI for that component or service voids all express and any implied warranties for the associated TI component or service and is an unfair and deceptive business practice. TI is not responsible or liable for any such statements.

Buyer acknowledges and agrees that it is solely responsible for compliance with all legal, regulatory and safety-related requirements concerning its products, and any use of TI components in its applications, notwithstanding any applications-related information or support that may be provided by TI. Buyer represents and agrees that it has all the necessary expertise to create and implement safeguards which anticipate dangerous consequences of failures, monitor failures and their consequences, lessen the likelihood of failures that might cause harm and take appropriate remedial actions. Buyer will fully indemnify TI and its representatives against any damages arising out of the use of any TI components in safety-critical applications.

In some cases, TI components may be promoted specifically to facilitate safety-related applications. With such components, TI's goal is to help enable customers to design and create their own end-product solutions that meet applicable functional safety standards and requirements. Nonetheless, such components are subject to these terms.

No TI components are authorized for use in FDA Class III (or similar life-critical medical equipment) unless authorized officers of the parties have executed a special agreement specifically governing such use.

Only those TI components which TI has specifically designated as military grade or "enhanced plastic" are designed and intended for use in military/aerospace applications or environments. Buyer acknowledges and agrees that any military or aerospace use of TI components which have **not** been so designated is solely at the Buyer's risk, and that Buyer is solely responsible for compliance with all legal and regulatory requirements in connection with such use.

TI has specifically designated certain components as meeting ISO/TS16949 requirements, mainly for automotive use. In any case of use of non-designated products, TI will not be responsible for any failure to meet ISO/TS16949.

Products

Audio	www.ti.com/audio
Amplifiers	amplifier.ti.com
Data Converters	dataconverter.ti.com
DLP® Products	www.dlp.com
DSP	dsp.ti.com
Clocks and Timers	www.ti.com/clocks
Interface	interface.ti.com
Logic	logic.ti.com
Power Mgmt	power.ti.com
Microcontrollers	microcontroller.ti.com
RFID	www.ti-rfid.com
OMAP Applications Processors	www.ti.com/omap
Wireless Connectivity	www.ti.com/wirelessconnectivity

Applications

Automotive and Transportation	www.ti.com/automotive
Communications and Telecom	www.ti.com/communications
Computers and Peripherals	www.ti.com/computers
Consumer Electronics	www.ti.com/consumer-apps
Energy and Lighting	www.ti.com/energy
Industrial	www.ti.com/industrial
Medical	www.ti.com/medical
Security	www.ti.com/security
Space, Avionics and Defense	www.ti.com/space-avionics-defense
Video and Imaging	www.ti.com/video

TI E2E Community

e2e.ti.com